

PLAN

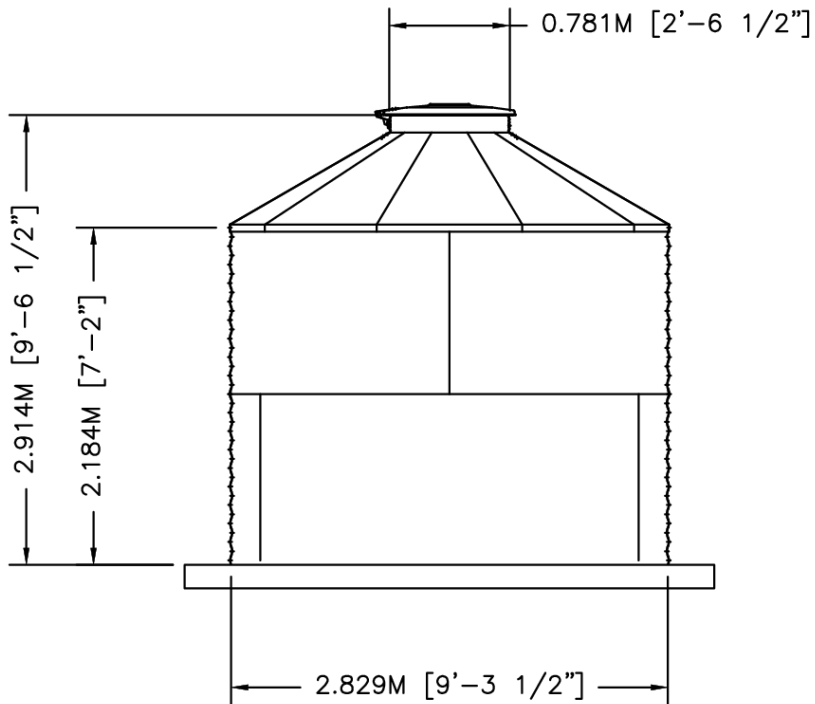

ELEVATION



	BY	DATE	TITLE	
DWN	XXX	XX/XX/XX	WTU03-02 30"PR 30DEG FLAT PANEL	
CKD			NOMINAL CAPACITY - 12.931 M3 [3,416 GAL]	
ENG			DWG. NO. SCT902-FP WTU03-02	REV. NO.
SIZE: A		SCALE: 1/4"=1'-0"		SHEET 1 OF 1